

Frame Round / Wall Frame Round Maxi



220-240V, 50/60Hz

<p>Frame Round/Wall</p> <p>Frame Round Maxi</p>	
<p>ca. 10° (max. 20°)</p> <p>Max. 16A</p> <ul style="list-style-type: none"> 0,5 - 1,0 mm² 8 mm 1,5 - 2,5 mm² 12 mm 	<p>Frame Sensor</p>
<p>Min 55mm</p> <p>Ø8mm</p> <p>40mm</p>	<p>NO: Skru av strømmen før montering. DK: Sluk for strømmen inden montering. SE: Stäng av strømmen innan montering. EN: Turn off power before installing. FR: Couper le courant avant l'installation. NL: Stroom uitschakelen voor u het toestel installeert. DE: Vor Installationsarbeiten den Strom abschalten. FI: Sammuta virta ennen kytkemistä</p> <p>NO: Kan kun installeres og vedlikeholdes av en registrert installasjonsvirksomhet. DK: Må kun installeres og vedligeholdes af uddannet elektriker. SE: Skall installeras och underhållas av behörig elektriker. EN: Only to be installed and maintained by an authorized electrician. FR: Doit être installé et maintenu par un électricien qualifié. NL: Mag alleen geïnstalleerd en onderhouden worden door een bevoegde electricien. DE: Dieses Produkt darf nur durch autorisiertes Personal (z.B. Elektro-Installateur) angeschlossen, in Betrieb genommen und gewartet werden. FI: Asentaa ja huoltaa saa vain valtuutettu sähköasentaja</p>

NORWAY
SG Armaturen AS

Skytterheia 25
N-4790 Lillesand

Tel: +47 37 50 03 00
firmapost@sg-as.no
www.sg-as.no

SWEDEN

SG Armaturen AB
Tel: +46 31 81 71 10
info@sg-ab.se
www.sg-ab.se

FINLAND

SG Armaturen Oy
Tel: +358 02 07 30 39 60
info@sg-oy.fi
www.sg-oy.fi

DENMARK

SG Armaturen A/S
Tel: +45 70 70 72 13
info@sg-as.dk
www.sg-as.dk

UNITED KINGDOM

SG Lighting LTD
Tel: +47 37 50 03 00
info@sglighting.co.uk
www.sglighting.co.uk

FRANCE

SG Lighting SA/NV
Tel: +33(0) 4 94 93 00 00
info.france@sglighting.fr
www.sglighting.net

BENELUX

SG Lighting SA/NV
Tel: +32(0) 15 20 72 71
info.benelux@sglighting.net
www.sglighting.net

GERMANY

SG Leuchten GmbH
Tel: +49 40 23 99 44 59
info@sg-leuchten.de
www.sg-leuchten.de

INTERNATIONAL

SG Lighting Co Ltd.
Tel: +86 769 88 49 20 88
cindy@sgdgc.com
www.sg-as.com

Dipswitch

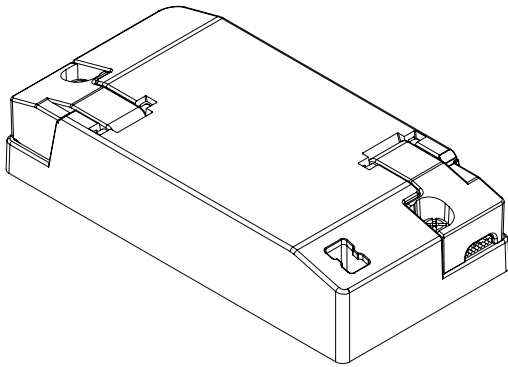

Standard

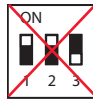
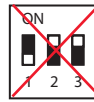
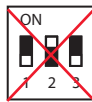

mA	200	250	300	350	400	450
Im	100%	125%	-	-	-	-

Frame Round/Wall

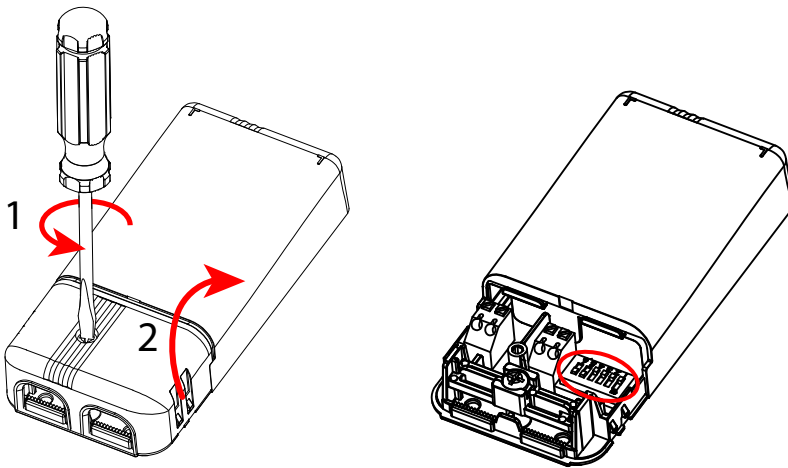

mA	250	300	350	400	450	500
Im	42%	50%	58%	67%	75%	83%

Frame Round Maxi

Standard



mA	550	600	650	700	750-900	12/24/28V
Im	92%	100%	108%	-	-	-

HC009S sensor



220-240V, 50/60Hz

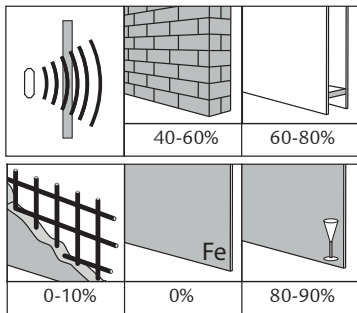
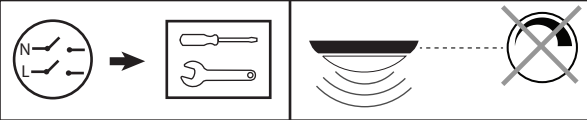

Standby power		< 0.5W
Microwave frequency		5.8GHz+/-75MHz
Microwave power		< 0.2mW

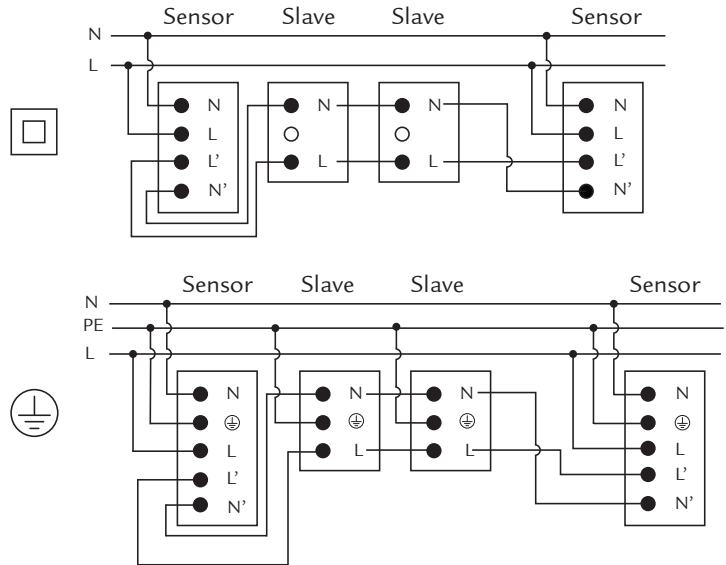

	1	2	3	
I	●	●	●	100%
II	○	●	●	75%
III	●	○	●	50%
IV	●	●	○	25%
V	○	○	○	10%

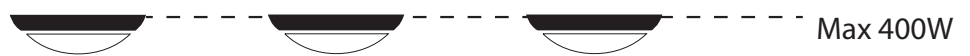

	1	2	3	4	
I	●	●	●	●	5s
II	○	○	●	●	30s
III	●	○	●	●	1min
IV	●	●	○	●	5min
V	●	●	●	○	15min
VI	○	○	○	○	30min

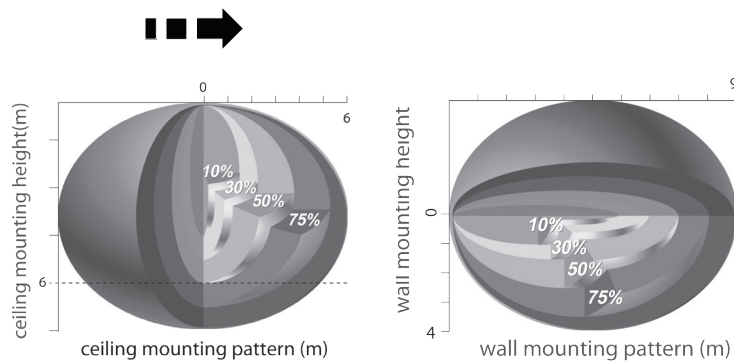

	1	2	3	4	
I	●	●	●	●	2 Lux
II	○	●	●	●	5 Lux
III	●	○	●	●	10 Lux
IV	●	●	○	●	30 Lux
V	●	●	●	○	50 Lux
VI	○	○	○	○	Disable

NORWAY
SG Armaturen AS

Skytterheia 25
N-4790 Lillesand

Tel: +47 37 50 03 00
firmapost@sg-as.no
www.sg-as.no

SWEDEN

SG Armaturen AB
Tel: +46 31 81 71 10
info@sg-ab.se
www.sg-ab.se

FINLAND

SG Armaturen Oy
Tel: +358 02 07 30 39 60
info@sg-oy.fi
www.sg-oy.fi

DENMARK

SG Armaturen A/S
Tel: +45 70 70 72 13
info@sg-as.dk
www.sg-as.dk

UNITED KINGDOM

SG Lighting LTD
Tel: +47 37 50 03 00
info@sglighting.co.uk
www.sglighting.co.uk

FRANCE

SG Lighting SA/NV
Tel: +33(0) 4 94 93 00 00
info.france@sglighting.fr
www.sglighting.net

BENELUX

SG Lighting SA/NV
Tel: +32(0) 15 20 72 71
info.benelux@sglighting.net
www.sglighting.net

GERMANY

SG Leuchten GmbH
Tel: +49 40 23 99 44 59
info@sg-leuchten.de
www.sg-leuchten.de

INTERNATIONAL

SG Lighting Co Ltd.
Tel: +86 769 88 49 20 88
cindy@sgdgc.com
www.sg-as.com

Sensor Dim

Motion and daylight

No Com

With Com

No Push

Push

NO: Impulsbryter (valgfritt)
 DK: Impulsafbryder (valgfritt)
 SE: Impulsbrytare (valgfritt)
 EN: Push button (optional)
 FR: Bouton-poussoir (optionnel)
 NL: Drukknop (optioneel)
 DE: Druckknopf (optional)
 FI: Painonappi (valinnainen)

		1	2
Hold time	10 minutes	1	1
	5 minutes	0	1
	1 minute	1	0
	5 seconds	0	0

		3	4
Motion sensitivity	High	1	1
	Medium	0	1
	Low	1	0
	Off	0	0

		5	6
Daylight sensitivity	Low	1	1
	Medium	0	1
	High	1	0
	Off	0	0

		7
Midnight cut	On	1
	Off	0

		8
Basic light	On	1
	Off	0

NORWAY
SG Armaturen AS

Skytterheia 25
N-4790 Lillesand

Tel: +47 37 50 03 00
firmapost@sg-as.no
www.sg-as.no

SWEDEN

SG Armaturen AB
Tel: +46 31 81 71 10
info@sg-ab.se
www.sg-ab.se

FINLAND

SG Armaturen Oy
info@sg-oy.fi
www.sg-oy.fi

DENMARK

SG Armaturen A/S
Tel: +45 70 70 72 13
info@sg-as.dk
www.sg-as.dk

UNITED KINGDOM

SG Lighting LTD
Tel: +47 37 50 03 00
info@sglighting.co.uk
www.sglighting.co.uk

FRANCE

SG Lighting SA/NV
Tel: +33(0) 4 94 93 00 00
info.france@sglighting.fr
www.sglighting.net

BENELUX

SG Lighting SA/NV
Tel: +32(0) 15 20 72 71
info.benelux@sglighting.net
www.sglighting.net

GERMANY

SG Leuchten GmbH
Tel: +49 40 23 99 44 59
info@sg-leuchten.de
www.sg-leuchten.de

INTERNATIONAL

SG Lighting Co Ltd.
Tel: +86 769 88 49 20 88
cindy@sgdgc.com
www.sg-as.com

Hold time



	1	2
10 min	1	1
5 min	0	1
1 min	1	0
5 sec	0	0



Motion sensitivity

Sensitivity	3	4
High	1	1
Medium	0	1
Low	1	0
Off	0	0

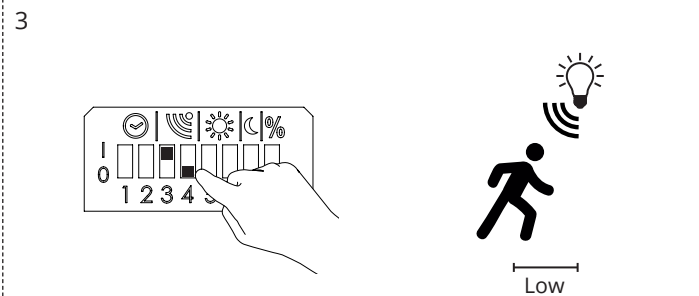
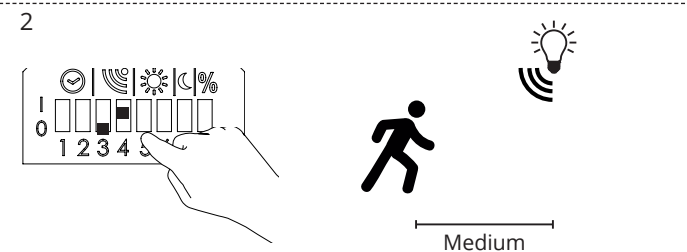
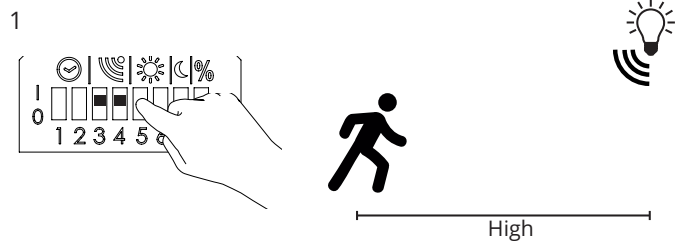
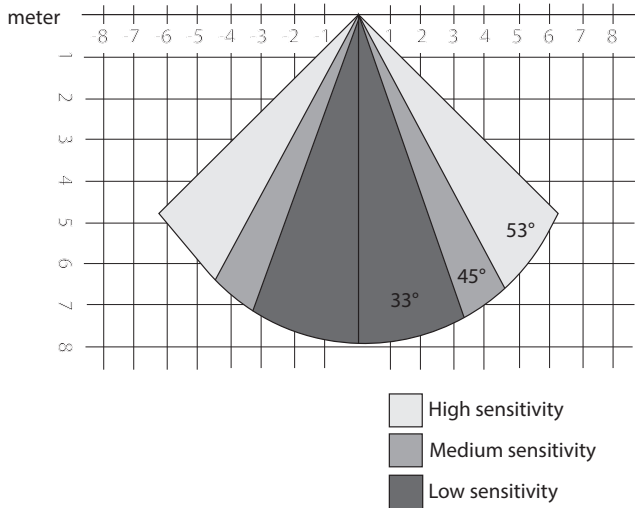

Daylight sensitivity

Sensitivity	5	6
Low	1	1
Medium	0	1
High	1	0
Off	0	0

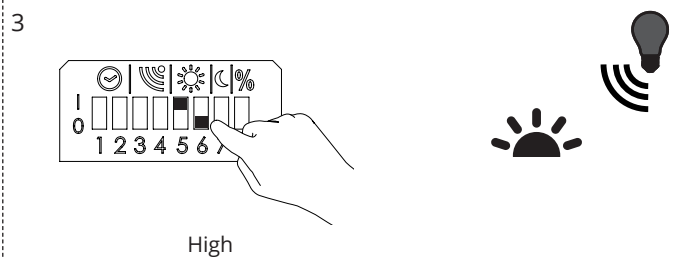
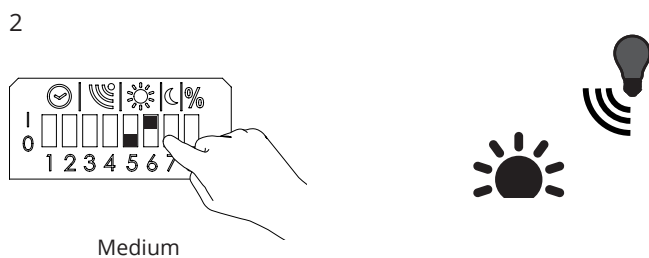
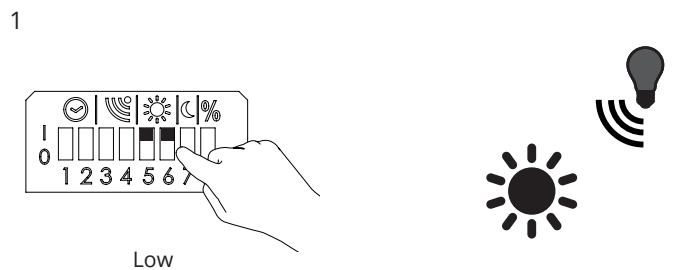

Midnight cut

~00:00 - 05:00 AM

~00:00 - 05:00 AM

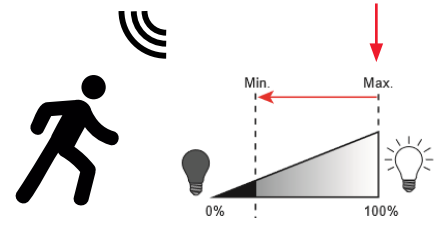
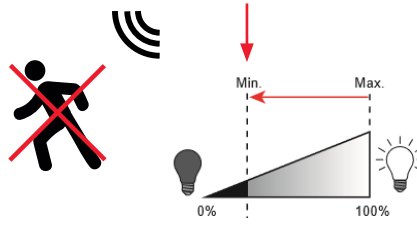
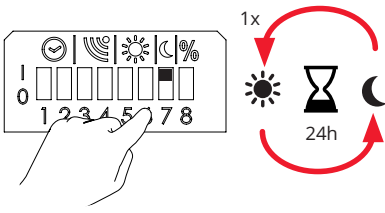

Light levels - Basic light and max light

1

2

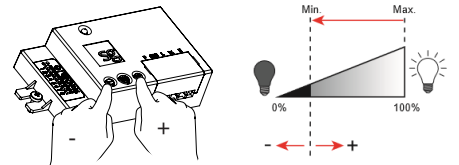
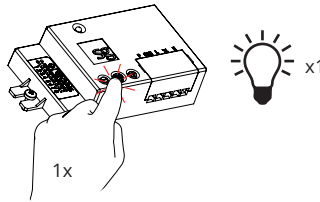
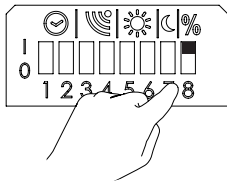

Basic light

3

4

5

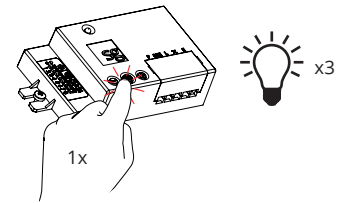
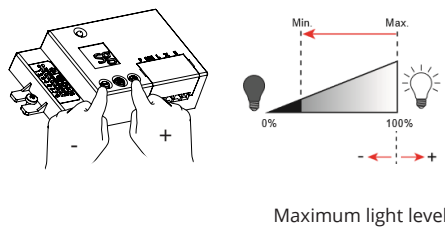
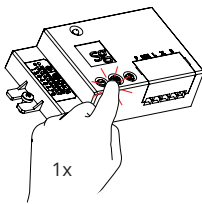

Light levels - Midnight cut

1

2

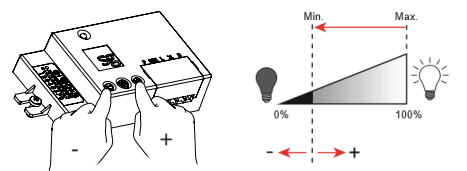
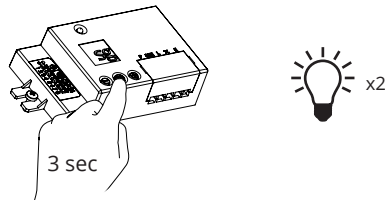
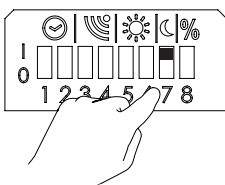

Minimum midnight cut

3

4

5

